

产品名称:CR-SCAN RAPTOR 3D 扫描仪说明书(中英)

单页尺寸: 210X140MM

封面材质: 210G铜版纸, 双面过哑胶

内页材质: 128G铜版纸, 双面过哑油

装订工艺: 骑马钉

印刷工艺: 四色印刷

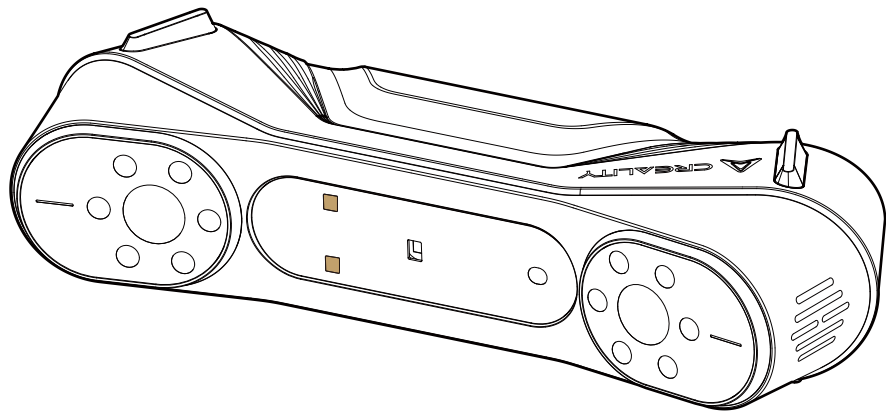

CR-SCAN RAPTOR

3D SCANNER

HYBRID BLUE LASER & NIR,
METROLOGY GRADE ACCURACY

Product Manual V1.1

01. About the Scanner

CR-Scan Raptor is a 3D scanner with metrology-grade accuracy, with a maximum accuracy of 0.02mm. Using a blue parallel 7-line laser and a 2.3-megapixel high-resolution camera for scanning, it produces richer details, sharper edges, and restores the 3D shape of the object accurately. Using all-glass lenses with large depth of field and low distortion, from coins or bolts to large objects (5mm-2000mm) can be scanned easily. All-metal lens barrel and lens base bring better mechanical stability and thermal stability.

In addition, it also incorporates infrared structured light technology, which can achieve marker-free point scanning and can scan faces, human bodies, cultural relics and other objects.

It has high precision, wide adaptability, low dependence on powder spraying, and can directly scan many black and metal objects. Unlike other industrial-grade line laser 3D scanners, it can also obtain the full-color texture of the object surface. With 12 white LED supplemental lights, it can obtain clear textures even in dark light environments.

Optimized grip and lightweight design (372g) can effectively reduce fatigue during long-term scanning. Mechanical buttons avoid accidental touch. Friendly interactive indicator lights make operation easier.

 Since the 3D scanner is a high-precision device, please handle it with care and store it properly. Avoid collisions or drops to prevent a decrease in accuracy or damage.

02. Product Specifications

Scanning Mode	CR-Scan Raptor		3D imaging camera resolution	1920x1200	Data interface	USB-C/USB3.0
Technical Principle	Blue Light (Blue 7-line laser)	NIR (infrared binocular structured light)	Device Dimensions	215mm x 50mm x 74mm	Calibration board	High-precision glass calibration board
Accuracy	Up to 0.02mm @ 100mm [1]	Up to 0.1mm	Device Weight	372g	Wireless Scanning	Supported in conjunction with future wireless scanning accessories
3D Resolution	0.02-2mm	0.1-2mm	Color Supplemental Light	12 white LEDs	System Support	Windows/macOS
Scanning Speed	Up to 60fps	Up to 20fps	Marker Recognition Enhancement	12 Blue LED	Operating temperature	-10°C to 40°C
Min. scanning volume	5mm x 5mm x 5mm	150mm x 150mm x 150mm	Laser Safety	Class I (eye safe)	Operating humidity	0-90%RH
Single Capture Range	270mm x 170mm@300mm	930mmx580mm@1000mm	Button	Mechanical		
Working distance	150mm-400mm	170mm-1000mm	IMU	Yes		
Color Mapping	Yes	Yes	Output format	OBJ/STL/PLY		
Alignment mode	Marker	Marker / geometry / texture	Input Power	12V=2A		[1] Accuracy is evaluated in laboratory conditions (measurement object is 100mm sphere pair) and actual results may be affected by operating environments such as temperature, vibration, and other factors.

03. Product Information

2.1 Equipment overview

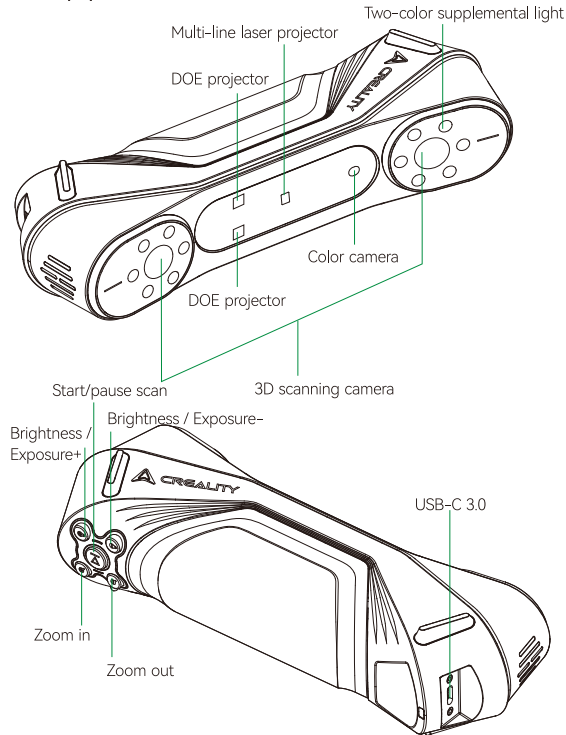

2.2 Button instructions

Button	Scanner feedback	LED indicator feedback
	Press once to start scanning; press again to pause scanning; press and hold for at least 3 seconds to end scanning.	The middle LED indicator flashes once
	Short press once to increase the Brightness/ exposure time of the 3D scanning camera by one level;	/
	Short press once, the 3D scanning camera Brightness / exposure time will be reduced by one level;	/
	Short press once, the 3D model will zoom in one level;	/
	Short press once to zoom out the 3D model by one level;	/

2.3 LED indicator instructions

LED indicator color	Status or meaning	Reference color
Green always on	The device is operating normally or the scanning distance is moderate	
Red and flashing	The device is in an abnormal status	
Yellow and flashing	The device is in an upgrading status	
Orange-red always on	The scanning distance is too close	
Orange always on	The scanning distance is close	
Light blue always on	The scanning distance is far	
Dark blue always on	The scanning distance is too far	

* When the distance LED indicator starts flashing during scanning, it indicates that scan tracking is lost. The scanner needs to return to the previously scanned area to backtrack and continue scanning.

*When the device is on standby, the LED indicator will enter a breathing state to save power.

04. Packing List

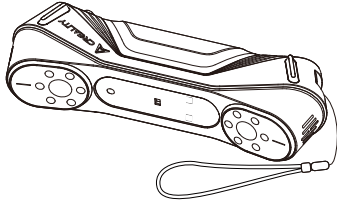

CR-Scan Raptor 3D scanner

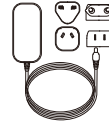

Power adaptor with international converter

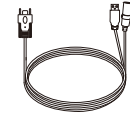

USB3.0 data cable (USB-C/USB-A, 3m)

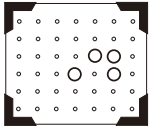

High-precision glass calibration board

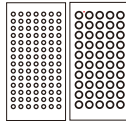

Reflective marker points (D6mm*2, D3mm*5)



Scanning pad (requires random application of 3mm markers for use)

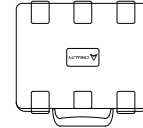

Portable case



Type-C converter

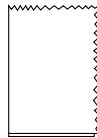

Cleaning cloth



Quick Operation Guide, Compliance Certificate & Warranty Card

05. Device Connection

1. Adapter installation and connection

Users can select the appropriate converter according to their location standards, then press the converter lock and push the selected converter upward until a click is heard. The specific operation is as shown below:

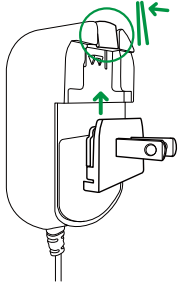

2. Device connection

1. Insert the USB-C interface of the data cable into the device and tighten the thumb screws;
 2. Connect the DC power cord female end of the data cable to the DC male end of the adapter;
 3. Plug the adapter into the power outlet;
 4. Plug the USB-A interface of the data cable into the USB3.0 interface of the computer;
- The specific operations are as shown below:

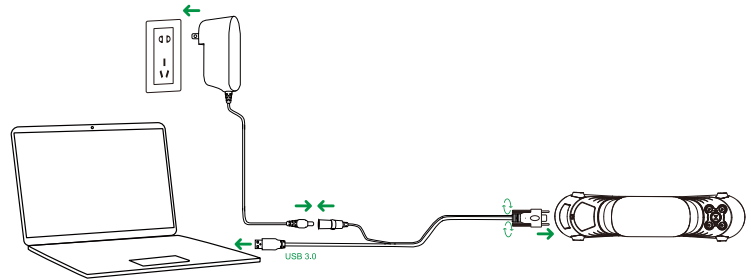

3. Note on use

When using the device, wear the lanyard around your wrist (as shown on the right) to prevent the device from falling and causing damage as shown right.

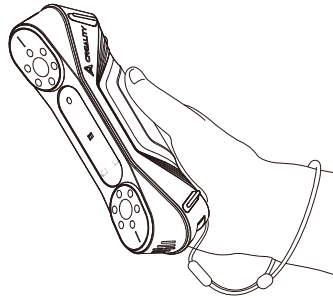

06. Creality Scan Software System Operation

6.1 Requirements of Creality Scan Software System



System requirements: Windows 10/11 (64 bit)
Configuration requirements
Recommended configuration: i7-Gen7 CPU, Nvidia graphics card (6GB VRAM), 16GB memory or higher



Recommended configuration
macOS: 11.7.7 and above
(Big Sur/Monterey/Ventura)
CPU: Apple M1/M2/M3 series processors;
RAM: 16GB or higher

6.2 Creality Scan software download and installation

Download link for Creality 3D Scanner Software: wiki.creality.com
Go to wiki.creality.com, click on [Software] -> [Creality Scan] to download the Creality scanning software and install it. Please ensure that the software version is 3.1.6 or higher to ensure the normal operation of the scanner.

Note: After installing the Creality Scan software on MAC, please authorize the software to read and write files to optimize point clouds and generate models when using the software.

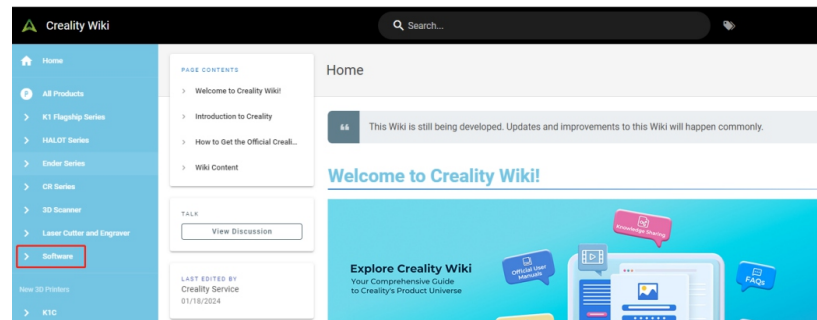

07. First Scan

1. Connect the device and launch Creality Scan software.



2. Click [New Scan] in the Creality Scan, as shown on the right:



3. Enter the project name in the pop-up bar, select the folder path, and then click the [OK] button, as shown on the right

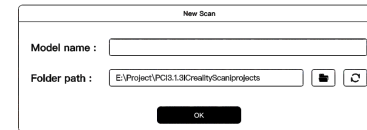

4. Enter "Model name", select "Folder path", and select the scanning mode and related configuration items according to the characteristics of the scanning object. Finally, click the [Scan] button to enter the scan preview interface, as shown on the right:

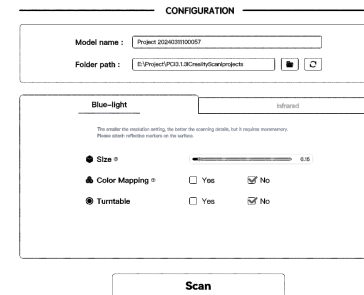

⚠ Caution

(1) If you need to scan objects with high precision, please select blue light mode (multi-line laser). In this case, marker point assistance is needed.

When the object is small, reflective marker points can be attached to the desktop or scanning pad, and there is no need to attach marker points to the surface of the object. If you want to scan the other side of the object, please use the multi-project stitching function of Creality Scan software to stitch the point clouds of multiple scans into a complete model.

When the object is large, the marker points need to be attached to the surface of the object.

(2) Select "No" in blue light mode, the fineness will be higher than "Yes".

(3) The smaller the point distance, the more refined the scanned model will be, but it will consume more memory and may also affect the scanning frame rate.

(4) Infrared mode can be used to scan faces, human bodies and other objects without marker points. Infrared scanning also supports texture mode and marker point mode scanning.

To learn more about the CR-Scan Raptor, please visit: <https://wiki.creality.com/3d-scanner>

The reference configuration of blue light mode is as follows:

CONFIGURATION

Model name :

Folder path :

Blue-light Infrared

The smaller the resolution setting, the better the scanning details, but it requires more memory.
Please attach reflective markers on the surface.

Size 0.15

Color Mapping Yes No

Turntable Yes No

Scan

The reference configuration of infrared mode is as follows:

CONFIGURATION

Model name :

Folder path :

Blue-light **Infrared**



Object	<input checked="" type="checkbox"/> Normal	<input type="checkbox"/> Face	<input type="checkbox"/> Body
Size	<input type="checkbox"/> Large	<input checked="" type="checkbox"/> Middle	<input type="checkbox"/> Small
Feature	<input checked="" type="checkbox"/> Geometry	<input type="checkbox"/> Texture	
Accuracy	<input checked="" type="checkbox"/> Hi-Quality		
Color Mapping	<input checked="" type="checkbox"/> Yes		
Turntable	<input type="checkbox"/> Yes	<input checked="" type="checkbox"/> No	

Scan

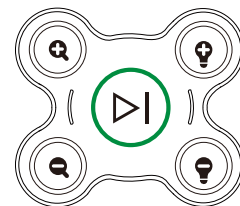

5. Adjust the scanner and the scanned test piece to the appropriate distance, that is, when the scanner LED indicator is green (as shown on the right), or when the distance indicator bar on the software interface is optimal, it means the best scanning distance.

Adjust the camera exposure time and laser brightness to an appropriate level, ensuring that the markers and laser are bright enough but not overexposed. For beginners, the software's automatic mode can be used. As users become more proficient, we recommend manual adjustment.

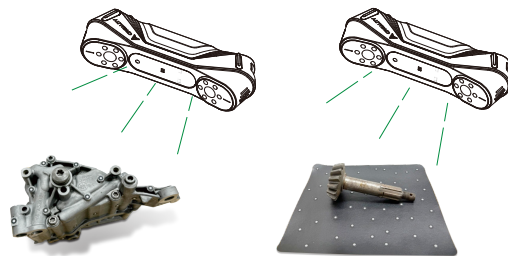

6. Press the  button on the scanner, or click the  button on the software interface, keep the scanner pointed at the object to be scanned and start scanning.



7. Use the scanner to scan the object 360°. When the scan is completed, press and hold  on the scanner for more than 3 seconds, or click  on the software interface to complete the scan and perform post-processing in the Creality Scan software to obtain a complete 3D model (it is recommended that the point distance be set to 0.1mm). The result is as shown on the right:



Note: The above key operations can also be operated in the Creality Scan software. For specific software operations, please visit: <https://wiki.creality.com/en/3d-scanner>

08. FAQs

- 1) How to achieve better model details?
 - ① The blue light mode is more precise than the infrared mode;
 - ② Adjust the exposure time of the IR camera during scanning to ensure moderate exposure. Overexposure is shown as red, while underexposure is shown as blue. In blue light mode, you also need to adjust the appropriate laser intensity;
 - ③ Try to maintain the optimal scanning distance. Generally, the closer the scanner is to the object without losing tracking, the better the details.
 - ④ During point cloud optimization, use a smaller point distance; when the object size is small, the point distance can be set to 0.1mm;
 - ⑤ When meshing, ensure that the number of model faces is sufficiently large.

For more scanning tips, please visit: <https://wiki.creality.com/en/3d-scanner>
- 2) How to scan the bottom of an object?
 - ① Creality Scan software provides a multi-project merging feature, allowing you to obtain the complete model of an object through multiple scans and merging;
 - ② First scan the visible part to obtain a partial model, then flip the object and continue scanning by backtracking to obtain a complete model (this method is only applicable when the marker points are attached to the surface of the object).
- 3) When do I need a scanning pad?

When scanning smaller objects (such as small parts, small figures, etc.), you can put marker points on the scanning pad and scan in marker point mode.
- 4) When do I need to use marker point mode?

Blue light mode requires reflective marker points;

Infrared mode: When the surface of the object does not have rich geometric features, you can stick reflective marker points on the surface of the object and scan in marker point mode.
- 5) When do I need to use texture mode?

When the surface of an object does not have rich geometric features but has rich textures (such as a vase), you can scan it directly in texture mode.
- 6) When calibration is required?

It needs to be calibrated when it is not being used for a long time (such as 3 months) or when the device experiences a collision.
- 7) Can I use calibration boards from other models of scanners?

Each calibration card is unique and corresponds to each scanner. They cannot be swapped. When using a calibration board for the first time, it needs to be scanned once to bind to the scanner using the QR code on the back. Otherwise, it may affect calibration accuracy.
- 8) What should be noted when storing calibration boards?

After each use, please carefully return the calibration board to its box for proper storage. Avoid contamination, scratching, or heavy pressure on the calibration board to prevent loss or damage.
- 9) How to perform calibration?

Connect the scanner to the computer, open the Creality Scan software, go to the [Device] interface, click on [Calibration], and perform calibration by following the animated instructions.

09. Troubleshooting

- Windows system computer cannot connect to the scanner;
If using a desktop computer, it is recommended to connect to the USB 3.0 port on the back of the main unit (USB 3.0 and above ports are usually blue or red);
Confirm that the system used is Windows 10/11 64-bit;
The entire installation path for the scanner software Crealitiy Scan must be in English.
- What to do if the preview video stream is not visible in the application on the Windows system;
Check whether the computer configuration meets the minimum configuration requirements of the scanner;
Please make sure to use the provided power adapter and make sure it is connected properly;
Open the Windows Device Manager and check if there is a "CR-Scan Raptor..." under "Cameras";
Open Windows Settings-Privacy-Camera, confirm whether the system camera permission is enabled, and ensure that desktop applications have permission to access the camera.
- What to do if the preview video is not visible in the application on the Mac system?
Check whether the computer configuration meets the minimum configuration requirements of the scanner;
Please make sure to use the provided power adapter and make sure it is connected properly;
Update the scanner to the latest firmware version;
Use a separate USB Type A to Thunderbolt or USB3 adapter. Avoid using multi-functional, multi-device USB-C adapter;
Install CrealitiyScan directly in the App directory. Do not install it in a subdirectory under the App directory.
- How to deal with USB 3.0 interface being recognized as USB 2.0 in the Windows system?
You can try to quickly re-insert the USB cable, or first connect the USB cable to the USB 3.0 interface on the PC, and then connect it to the USB-C interface of the scanner.

For more questions, please refer to the creality wiki: <https://wiki.crealitiy.com/en/3d-scanner>

Facebook Community
Discussion, sharing, and
troubleshooting



Crealitiy wiki
The step-by-step guide to
help you get started



SHENZHEN CREALITY 3D TECHNOLOGY CO.,LTD.

Official Website: www.crealitiy.com

Business Tel: +86 755-8523 4565 E-mail: cs@crealitiy.com

Company Address: 18th Floor, JinXiuHongDu Building, Meilong Road,
Xinniu Community, Minzhi Street, Longhua District, Shenzhen City, China.



一、产品简介

CR-Scan Raptor是一款具有计量级精度的3D扫描仪，最高精度可达0.02mm。采用蓝色平行7线激光和230万像素的高分辨率相机进行扫描，细节更加丰富，边缘更加锐利，能够精确还原物体的3D形貌。采用大景深、低畸变的全玻璃镜头，从硬币、螺栓，到大型零部件（5mm-2000mm），都可以轻松扫描。全金属镜筒和镜头底座，带来更好的机械稳定性和热稳定性。

此外，它还融合了红外结构光技术，可以实现无标记点扫描，可扫描人脸、人体、文物等目标。

它精度高，适应范围广，对喷粉的依赖性低，对于很多黑色物体和金属物体能直接扫描。与其他的工业级线激光3D扫描仪不同的是，它还可以获取物体表面的全彩纹理。12颗白光LED补光灯，在暗光环境下也能获得清晰的纹理。

优化的握持感，轻巧型设计（轻至372g），可有效降低长时间扫描的疲劳感。机械按键，不易误触。友好的交互指示灯，操作更轻松自如。

⚠ 3D 扫描仪为高精度设备，请轻拿轻放，妥善保存。请勿碰撞或跌落，以免造成精度下降或损坏。

二、产品参数

产品名称	CR-Scan Raptor		3D成像相机分辨率	1920x1200	数据接口	USB-C/USB3.0
技术原理	蓝色7线激光	红外双目结构光	产品尺寸	215mm x 50mm x 74mm	标定板	高硼硅玻璃基板
精度	Up to 0.02mm@100mm [1]	Up to 0.1mm	产品重量	372g	无线扫描	支持（需搭配配件）
点距	0.02-2mm	0.1-2mm	RGB补光灯	12颗白色LED	系统支持	Windows/macOS
扫描速度	最高60fps	最高20fps	标志点补光灯	12颗蓝光LED	工作温度	-10°C to 40°C
最小扫描体积	5mm x 5mm x 5mm	150mm x 150mm x 150mm	激光安全	Class I (eye safe)	工作湿度	0-90%RH
幅面	270mm x 170mm@300mm	930mm x 580mm@1000mm	按键	机械式	[1] 精度是在实验室环境中评估的（测量对象为100mm双小球球心距），实际结果可能会受到操作环境的影响，如温度、振动和其他因素。	
工作距离	150mm-400mm	170mm-1000mm	IMU	支持		
色彩贴图	支持	支持	输出格式	OBJ/STL/PLY		
拼接模式	标志点	标志点/几何/纹理	输入电源	12V 2A		

三、产品信息

2.1 设备简介

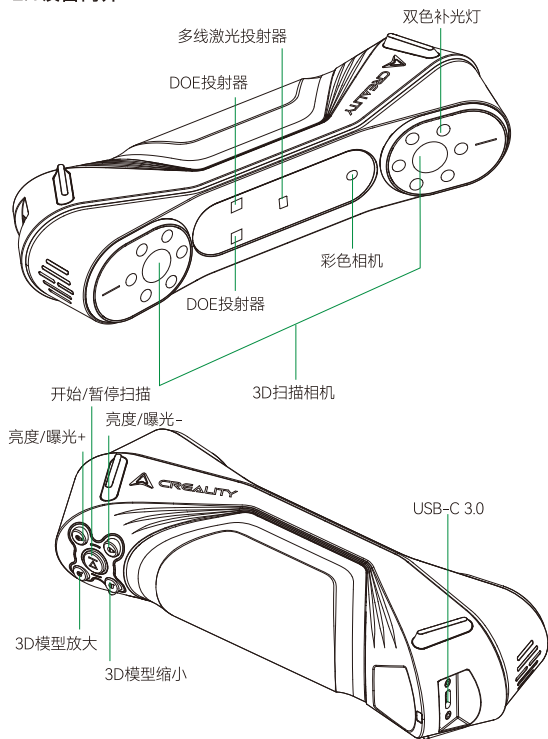

2.2 按键说明

按键	扫描仪反馈	指示灯反馈
	短按一次，开始扫描；再短按一次，暂停扫描；长按≥3S，结束扫描。	中间指示灯闪烁一次
	短按一次，3D扫描相机曝光时间增强一级；	/
	短按一次，3D扫描相机曝光时间减弱一级；	/
	短按一次，3D模型放大一级；	/
	短按一次，3D模型缩小一级；	/

2.3 指示灯带说明

指示灯带颜色	状态或含义	参考颜色
绿色长亮	设备正常运行或扫描距离适中	
红色并闪烁	设备处于异常状态	
黄色并闪烁	设备处于升级状态	
橙红色长亮	扫描距离过近	
橙色长亮	扫描距离较近	
浅蓝色长亮	扫描距离较远	
深蓝色长亮	扫描距离过远	

*当在扫描中，距离指示灯开始闪烁时，意味着扫描跟踪丢失，需要扫描仪重新回到已经扫描过的区域，恢复扫描拼接关系。

*当设备待机时，指示灯会进入呼吸状态，以节省电量。

四、装箱清单

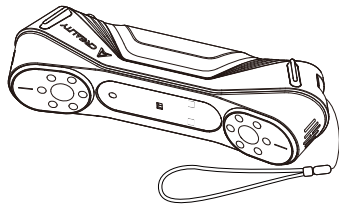

CR-Scan Raptor 3D扫描仪



适配器+转接头

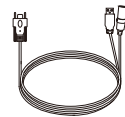

USB3.0数据线
(USB-C/USB-A, 3m)

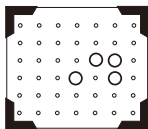

高精度玻璃标定板

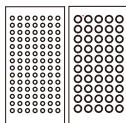

反光标志点
(D6mm*2张, D3mm*5张)



扫描垫 (需随机粘贴3mm标志点进行使用)

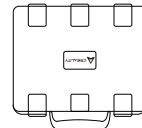

便携箱



USB-C转接头

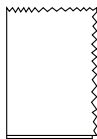

清洁布

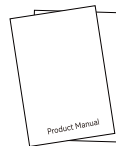

快速操作指南 合格证&保修卡

五、连接设备

1、适配器安装连接

用户根据自己所在国家，选择合适的适配器转换头，然后按下适配器锁扣，并把选定的转换头往上推，听到咔的一声即安装OK，具体操作如下图：

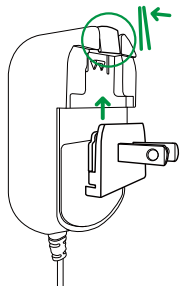

2、设备连接

- 1、将数据线的USB-C接口插入设备中，并且锁紧螺钉；
 - 2、数据线的DC电源线母头和适配器的DC公头连接；
 - 3、适配器插入电源排插；
 - 4、数据线的USB-A接口插入电脑的USB3.0接口；
- 具体操作如下图：

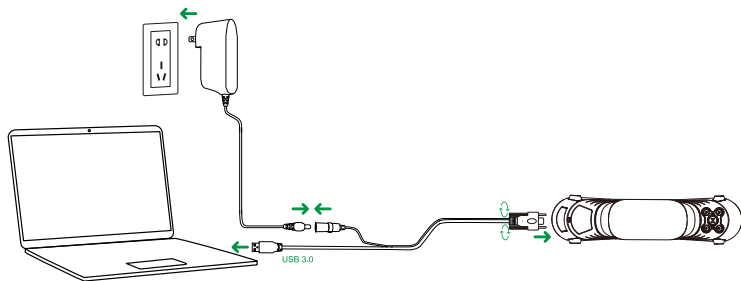

3、使用注意

使用设备时，挂绳系在手腕上（如右图），防止设备跌落，对设备造成损伤。

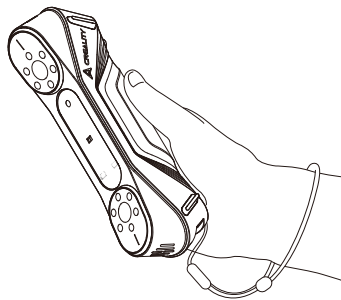

六、Creality Scan软件系统操作

6.1 Creality Scan软件系统要求



系统要求: Windows 10/11(64 bit)
配置要求
推荐配置: i7-Gen7 CPU, Nvidia显卡 (6GB显存),
16GB内存以上:



推荐配置
macOS: 11.7.7及以上(Big Sur/Monterev/Ventura)
CPU: 推荐使用M1/M2/M3系列处理器, 内存16GB

6.2 Creality Scan软件下载及安装

创想三维扫描仪电脑软件下载地址: wiki.creality.com
进入创想wiki站点 wiki.creality.com 点击【Software】
->【Creality Scan】下载创想扫描软件并进行安装。
请确保软件版本为3.1.6及以上, 以确保扫描仪正常工作。

注意: 在MAC上完成Creality Scan软件安装后,
请授权本软件读写文件的权限, 以使用该软件时
优化点云并生成模型。

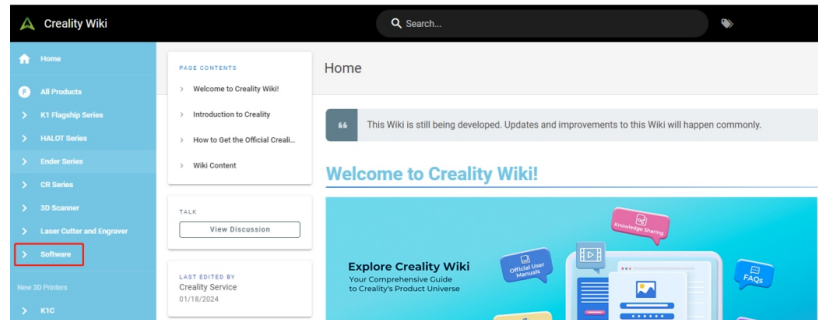

七、首次扫描

1.连接好设备，打开安装好的Creality Scan软件。



2.在Creality Scan软件中点击【新建扫描】，如右图：



3.在弹出栏输入工程名称，并选择文件夹路径，然后点击【确认】按钮，如右图：



4. 输入“模型名称”，选择“储存位置”，并根据扫描对象的特征选择扫描模式以及相关配置项。最后点击【开始扫描】按钮，进入扫描预览界面，如右图：



⚠ 注意

- (1) 如果需要对物体进行高精度扫描，请选择蓝光模式（多线激光），此时需要标记点辅助。
物体较小时，可以将反光标记点贴在桌面或扫描垫上，物体表面不需要贴标记点。如要扫描物体的另一面，请用Creality Scan软件的多工程拼接功能，将多次扫描的点云拼接成一个完整的模型。
物体较大时，需要把标记点贴在物体表面。
- (2) 蓝光模式下，彩色贴图选择“否”，精细度会选择“是”更高。
- (3) 点距越小，扫描的模型越精细，但会消耗更多的内存，也可能会影响扫描帧率。
- (4) 红外模式可以用于扫描人脸、人体等目标，无需贴标记点。红外扫描也支持纹理模式和标记点模式扫描。
如需了解更多关于CR-Scan Raptor的信息，请访问：<https://wiki.creality.com/3d-scanner>

蓝光模式参考配置如下：

扫描配置

模型名称：

储存位置：  

蓝光 | 红外

※ 分辨率越高，扫描精度越好，但需要更多内存，请在电脑上贴标记点。

● 目标大小 ◯

🎨 彩色贴图 ◯ 是 否

🔄 转盘模式 ◯ 是 否

开始扫描

红外模式参考配置如下：

扫描配置

模型名称：

储存位置：  

蓝光 | **红外**

🎯 扫描对象 ◯ 物体 人脸 身体

● 目标大小 ◯ 大 中 小

🔍 特征类型 ◯ 几何 纹理

H 扫描精度 ◯ 高质量

🎨 彩色贴图 ◯ 是

🔄 转盘模式 ◯ 是 否

开始扫描

5.调整扫描仪和扫描测试件到合适距离，即扫描仪指示灯为绿色（如右图），或软件界面距离指示条处于最佳时，表示此时处于最佳扫描距离。调节相机曝光时间和激光亮度至合适的水平，使得标记点和激光足够亮，但不要过曝。对于新手，可以采用软件提供的自动模式。熟练以后，我们推荐用户手动调节。

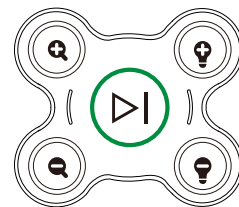

6.在扫描仪上短按 (▶) 按键，或在软件界面点击 (▶) 按钮，并保持扫描仪对准被扫描物，开始进行扫描。

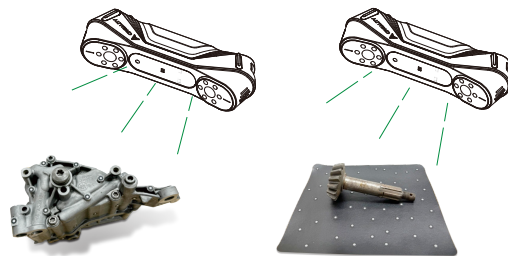

7.用扫描仪对被扫描物进行360°扫描，当扫描完成时，在扫描仪上长按 (▶) 超过3S，或在软件界面点击 (●)，即可完成扫描，在Creality Scan软件进行后处理即可得到完整的3D模型（点距建议为0.1mm），效果如右图：



注：以上按键操作也可在Creality Scan软件操作，软件具体操作可访问：<https://wiki.creality.com/en/3d-scanner>

八、常见问题

• 1) 如何得到更好的模型细节？

- ① 蓝光模式比红外模式精细度更高；
- ② 扫描过程中，调节合适的IR相机曝光时间，使得曝光适中，过曝为红色，曝光不足为蓝色；蓝光模式下，还需要调节合适的激光强度；
- ③ 尽量保持最佳扫描距离。小物体模式下，通常扫描仪离物体越近细节越好。
- ④ 在点云优化时，需要设置较小的点距；当物体尺寸较小时，点距可以设到0.1mm；
- ⑤ 构网时，模型的面片数要设的足够大。

了解更多的扫描技巧，请访问：<https://wiki.creality.com/en/3d-scanner>

• 2) 如何扫描物体的底部？

- ① Creality Scan软件提供了多工程拼接的功能，可以通过多次扫描、拼接的方式，得到物体的完整模型；
- ② 先扫描可见部分得到部分模型，然后翻转物体，通过重定位继续扫描，得到完整的模型（该方式只适用于标记点贴在物体表面的情况）。

• 3) 什么情况下可以使用扫描垫？

当扫描较小的物体（如小零件、小手办等）时，可以在扫描垫上贴标记点，用标记点模式进行扫描。

• 4) 什么情况需要用标记点模式？

蓝光模式需要反光标记点；

红外模式：当物体表面几何特征不丰富时，可以在物体表面粘贴反光标记点，用标记点模式进行扫描。

• 5) 什么情况可以用纹理模式？

当物体表面几何特征不丰富、但纹理很丰富时（如花瓶），可以直接用纹理模式进行扫描。

• 6) 什么情况下需要标定？

当长时间不用（比如3个月），或设备经历碰撞时需要标定一次。

• 7) 可以用其他型号扫描仪的标定板吗？

每台标定板唯一并对应每台扫描仪，不能随意互换使用，第一次使用时，需要先扫描一次标定板背面的二维码进行绑定，否则会影响标定精度。

• 8) 标定板储存有什么注意事项？

每次使用完标定板后，请小心放回箱包内妥善保管好，切勿污染、划伤，重物挤压标定板，避免标定板遗失或损坏。

• 9) 如何进行标定？

连接扫描仪至电脑，在打开Creality Scan软件进入【快速标定设备】界面，点击【标定】并按照动画提示进行标定即可。

九、故障排除

- Win系统电脑连接不到扫描仪;
如果使用台式机, 建议连接到主机背面的USB 3.0接口上 (USB3.0及以上接口通常为蓝色/红色);
确认使用windows 10/11 64bit的系统;
扫描仪软件Crealty Scan安装路径必须为全英文的路径下。
- 在win系统上的应用中看不到预览视频流怎么办;
检查电脑配置是否满足扫描仪最低配置要求;
检查是否使用随包赠送的适配器给设备供电, 并确保其连接正常;
打开windows 设备管理器, 在“Cameras”中查看是否有“CR-Scan Raptor...”相关相机;
打开windows设置 - 隐私 - 相机, 确认系统相机权限是否已打开, 确认桌面应用是否有权限可以访问相机。
- 在Mac系统的应用上看不到预览视频怎么办?
检查电脑配置是否满足扫描仪最低配置要求;
检查是否使用随包赠送的适配器给设备供电, 并确保其连接正常;
扫描仪更新到最新固件版本;
使用独立的USB-A转雷雳或USB3的转接头, 请尽量不要使用多功能多设备的USB-C转接器;
把CrealtyScan直接安装在App目录下, 请不要安装在App目录下的子目录下。
- 在win系统中, 使用 USB3.0 接口被识别为USB2.0该怎么处理?
可尝试重新快速地插入USB线, 或者先把USB线接入PC端的USB3.0接口, 然后再接入扫描仪的USB-C接口。
其他更多问题请参考 creality wiki: <https://wiki.creality.com/en/3d-scanner>

深圳市创想三维科技股份有限公司

公司官网: www.creality.cn 服务热线: 400 6133 882

电子邮箱: cs@creality.com

办公地址: 深圳市龙华区民治街道新牛社区梅龙大道锦绣鸿都大厦18F

工厂地址: 深圳市龙华区大浪街道浪口社区华旺路156号厂房

手把手教程



REACH



WARRANTY

Name: _____ Telephone: _____

Address: _____ E-mail: _____

Serial Number: _____ Order Number: _____

Channel: Platform Offline Repair Change Return

Date of purchase Day _____ Mon. _____ Year _____

Malfunction And Damage Depiction Or Return And Change Reasons\Suggestions: _____

Repair Records: _____

Before returning the product and filling in a warranty, please contact after-sale person for going through after-sale formality. And attach this warranty card along with the returned machine.

Note: Client need filling in basic info. and return reasons. Repair records shall retain for technicians.

产品保修卡

客户名称: _____ 联系电话: _____

收件地址: _____ 电子邮箱: _____

机器制造编码: _____ 订单编号: _____

购买渠道: 电商平台 线下 返修 换货 退货

购买日期: _____ 年 _____ 月 _____ 日

故障描述或退、换货原因和建议: _____

维修情况记录: _____

产品寄回前请先联系售后专员, 为正常进行售后处理, 请务必填写此卡, 并随机器寄回。

温馨提示: 基本信息及返厂原因为客户必填项, 维修情况记录部分为维修人员填写项





www.creality.com